

DATE PROJECT TYPE

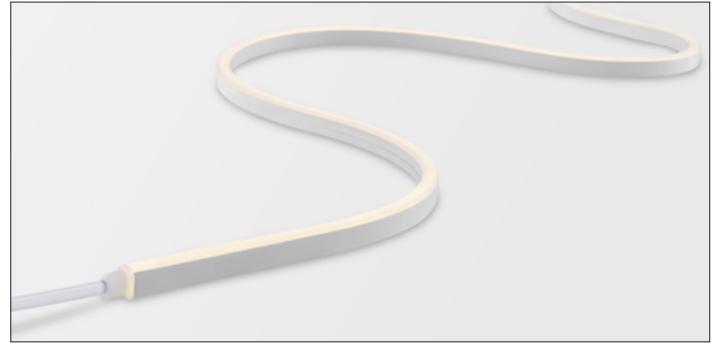

PRODUCT FEATURES

- Seamless Spot Free Illumination
- Ultra Slim
- Close Pitch LEDs
- Bend Direction Horizontally / Vertically
- Dimmable
- Indoor and Outdoor Application
- Tunable color range 22K-40K

PRODUCT SPECIFICATIONS

IP Rate	IP67 with Factory Termination (Customized Length Available)
	IP65 with Field Termination
Lamp Power	5.9W/ft
Power Input	24V DC
Color Rendering	Ra>80
Operating Temperature Ranges	14°F to 122°F (-10°C to 50°C)
Maximum Length	16.4ft (5,000mm)
Minimum Length	1.97in (50mm)
Minimum Bending Diameter	3.93in (100mm)
Beam Angle	130°
Material	PVC

SPECIFICATIONS TABLE



Model Name	Power Input	Lamp Power	Luminous Flux (Full Brightness)	Color Temperature
FN1 SC-24V-1M	DC 24V	19.2 W	505 lm	2,200K-4,000K

PHYSICAL SPECIFICATIONS

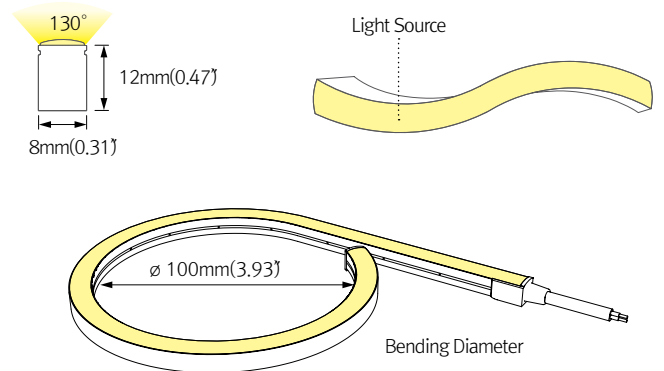

SPECIFICATION GUIDE

NOT TO BE USED FOR ORDERING. The Specification Guide is intended solely to ensure that all options are considered.

MODEL	COLOR	FEED TYPE	MOUNTING	DRIVER	VOLTAGE
FN1	SC-22K-40K	STD - Straight Feed LS - Left Side Feed BS - Bottom Feed*	STD - Flat Brackets EXL - 4Extrusion*	NDM Non-Dim FDC 0-10 Interface FDH Forward Phase RDH Reverse Phase	120V 240V 277V

* Available, As Special Order Consult Feelux Lighting

DIMENSIONS

TOP VIEW

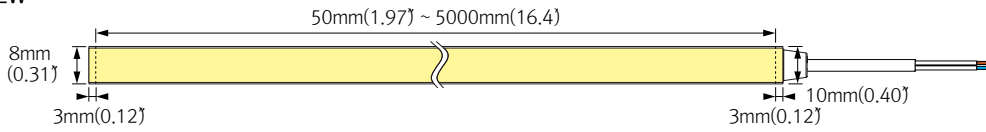

SIDE VIEW

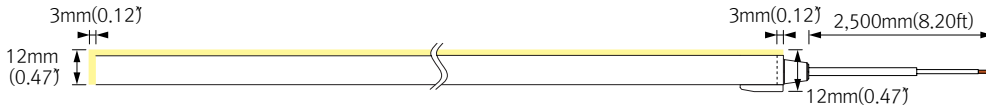

BOTTOM VIEW

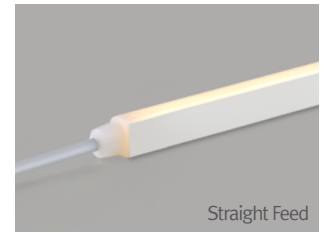
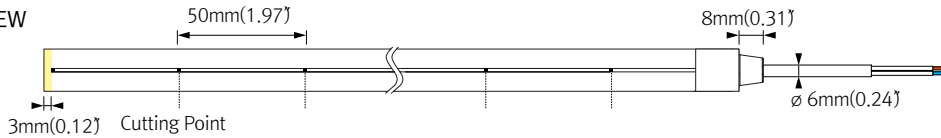

Straight Feed

TOP VIEW

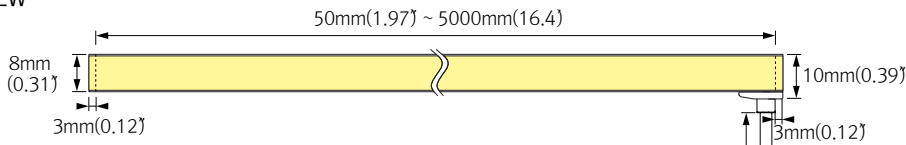

SIDE VIEW



BOTTOM VIEW

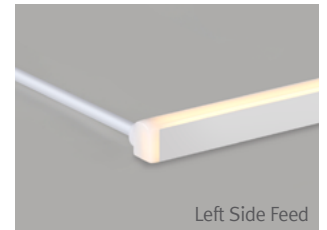
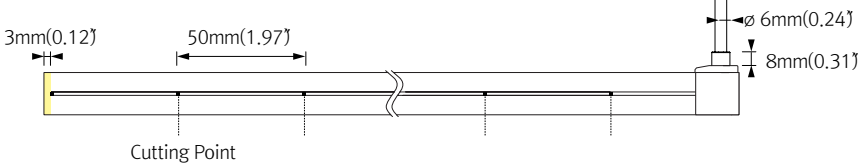

Left Side Feed

TOP VIEW

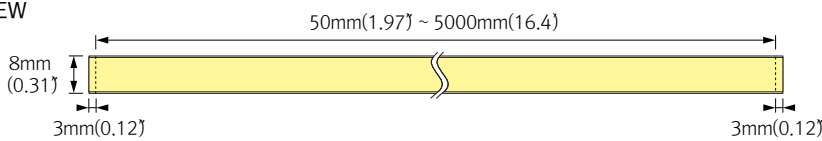

SIDE VIEW

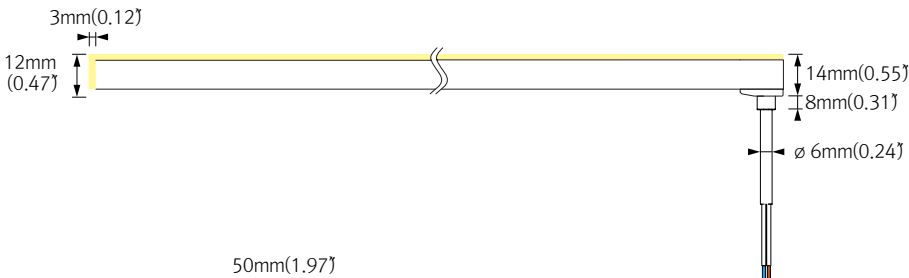

BOTTOM VIEW

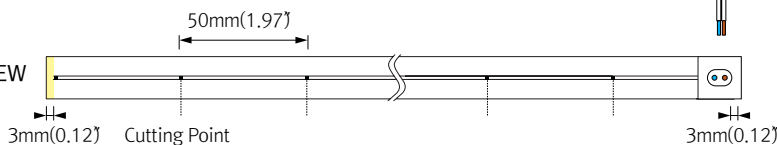

Bottom Feed

FLXible Neon can be cut every 50mm (1.97).

Please follow the cutting point mark to cut precisely as needed.

BEAM SPREADS

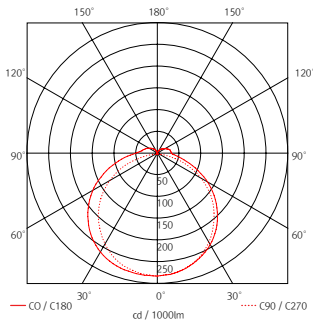

FN1 SC-24V-1M
45.2 lm/W
867 lm

INSTALLATION – Bracket

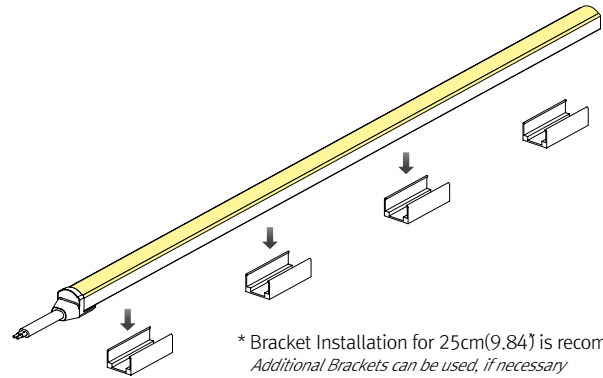

INSTALLATION – Field Termination (IP65)

* Components

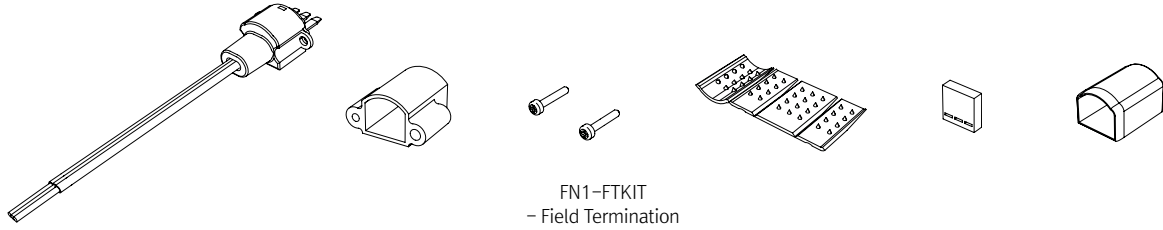

* Expanded View

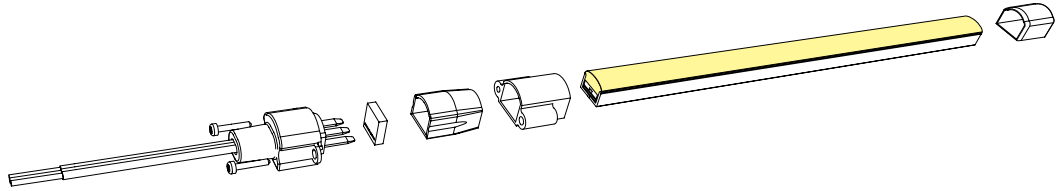

COMPONENTS



FLXible Neon 2
 _FN1-SC-24V-5m(16.4)
 _FN1-SC-24V-4m(13.1)
 _FN1-SC-24V-3m(9.8)
 _FN1-SC-24V-2m(6.6)
 _FN1-SC-24V-1m(3.3)



Expanding Stick
 _FN-EPS

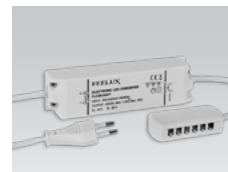

LED Drivers
 With distributor and power cord 1800mm (6)
 _FLC30-24V/XL
 _FLC75-24V/XL



Mounting Brackets
 _FN1-BRACKET1



Field Termination
 _FN1-FTKIT-DUAL



Hard Wire Driver
 (90V to 300V)
 _XLAV80(L)-124V-SSB
 _XLD200-224V-FCL-DIM
 _XLD75-124V-FC

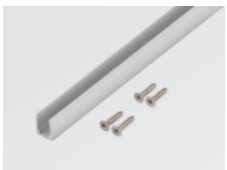

FN2 Extrusion Line
 _FN1-EXL (4)



Dimming Interface
 Max. 100W (100W/CH, 1CH)
 0-10V Signal
 _FDC-L10



12 Port Hub
 _D12P-HUB
 Included with Cord and Plug drivers. Order separately for Hard Wire or 3rd Party Drivers

A larger selection of drivers are available including remote and hard wire drivers. Please consult factory.