

PRODUCT FEATURES

- Seamless Spot Free Illumination
- Ultra Slim Profile
- Close Pitch LEDs
- Perfected Color Consistency
- Even Surface Illumination
- Multiple Lengths for Easy Configuration
- End to End Snap-In Connection
- Dimmable with 0-10V, Forward/Reverse Phase
Other Options Available
- Side-Feed Units for Long Continuous Runs
- Title 24 Compliant
- Quick Ship Available*

PRODUCT SPECIFICATIONS

- 24V DC Constant Voltage Feelux or Approved Class 2 Drivers
- Operating Temperature: 32-113°F (0-45°C)
- Lamp Life: 50,000 hrs L70
- Available Color: 2700K, 3000K, 3500K, 4000K
- CRI/Ra > 90
- 83.5lm/W – 3.9W/ft – 327lm/ft (NDPro 15W 4000K)
- IP20 – Damp Location/Closet Approved
- Beam Angle: 120°
- Finish: Aluminum
- 5 year Warranty
- Product is approved for Closet/Storage space installation per NEC410.16 (A) (3) and NEC410.16 (C)(5) per NRTL certification

DIMENSIONS

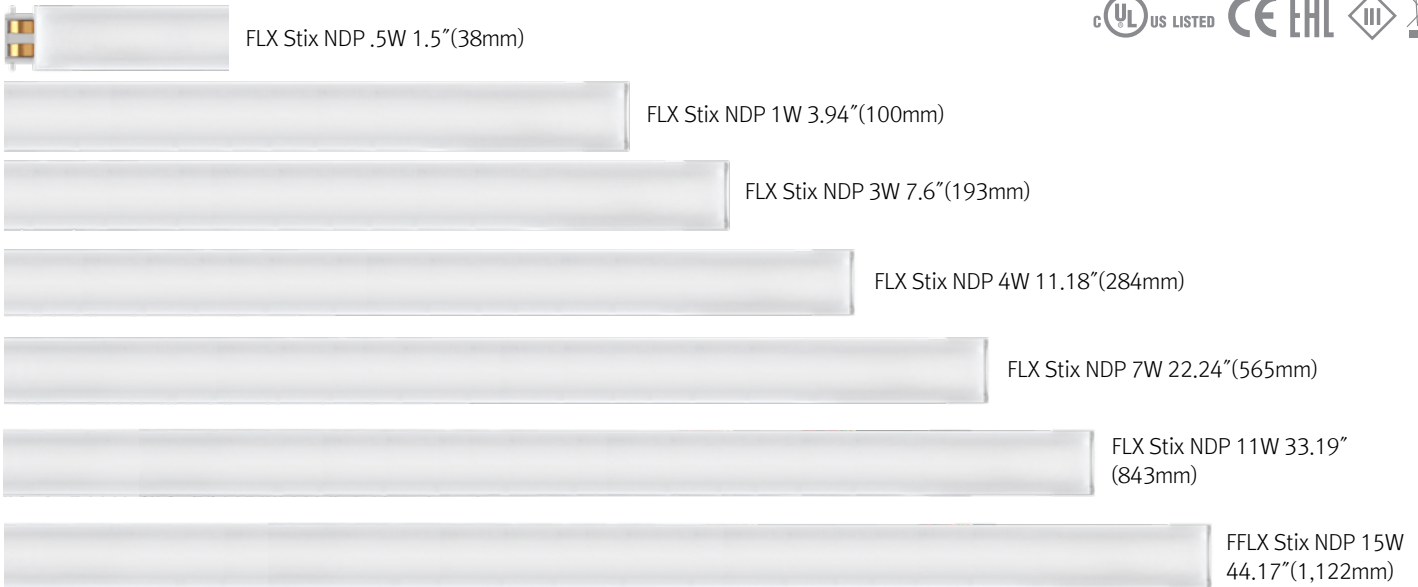

Model Number	Voltage Input (V)	Power Input (W)	Luminous Flux (lm) / 4000K	Color Rendering	A inches (mm)	B inches (mm)	C inches (mm)
NDP1-(Color)K-24V-C90-L38	DC24	0.49	41.9	Ra>90	1.3 (33)	1.5 (38)	2.17 (55)
NDP1-(Color)K-24V-C90	DC24	1.2	93.6	Ra>90	3.74 (95)	3.93 (100)	4.6 (117)
NDP3-(Color)K-24V-C90	DC24	2.37	186.9	Ra>90	7.4 (188)	7.6 (193)	8.26 (210)
NDP4-(Color)K-24V-C90	DC24	3.59	290.3	Ra>90	10.99 (279)	11.18 (284)	11.85 (301)
NDP7-(Color)K-24V-C90	DC24	7.17	568.4	Ra>90	22 (560)	22.24 (565)	22.91 (582)
NDP11-(Color)K-24V-C90	DC24	10.62	857.5	Ra>90	33 (838)	33.18 (843)	33.85 (860)
NDP15-(Color)K-24V-C90	DC24	14.42	1,203	Ra>90	43.98 (1,117)	44.17 (1,122)	44.84 (1,139)

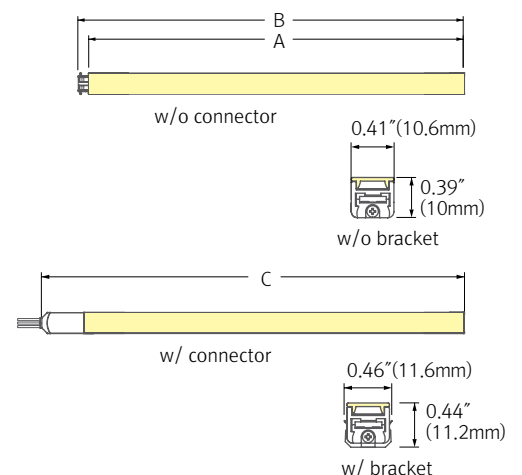

EASY CONNECTION

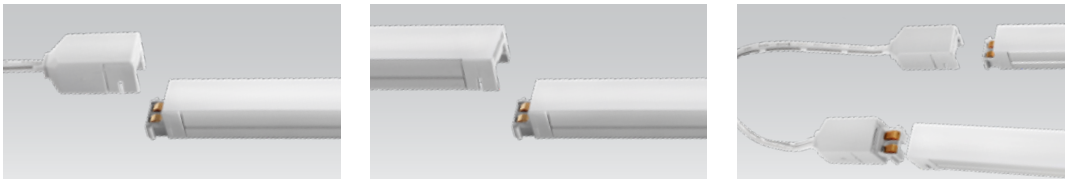

MAGNET

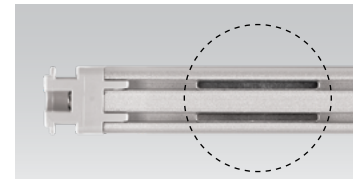

OPTIONS

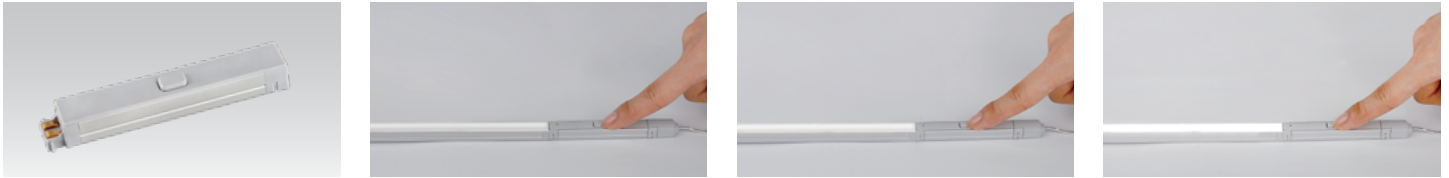

INSTALLATION

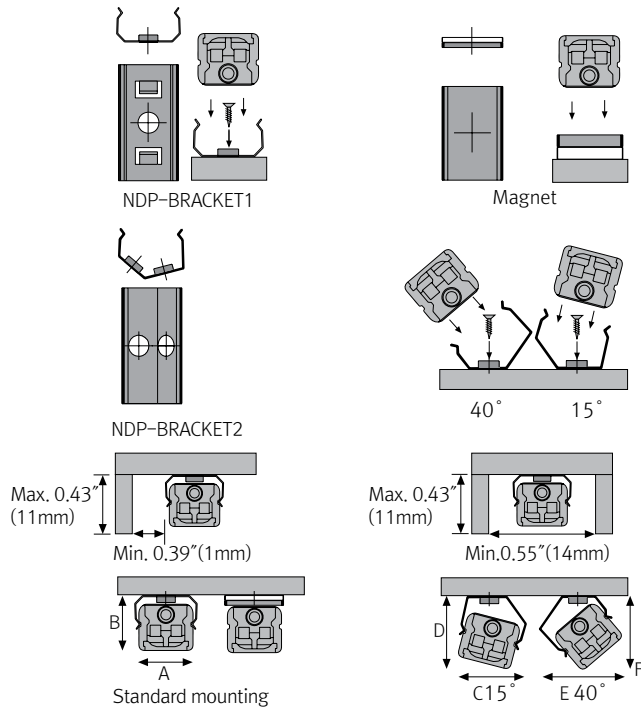

DIMENSION

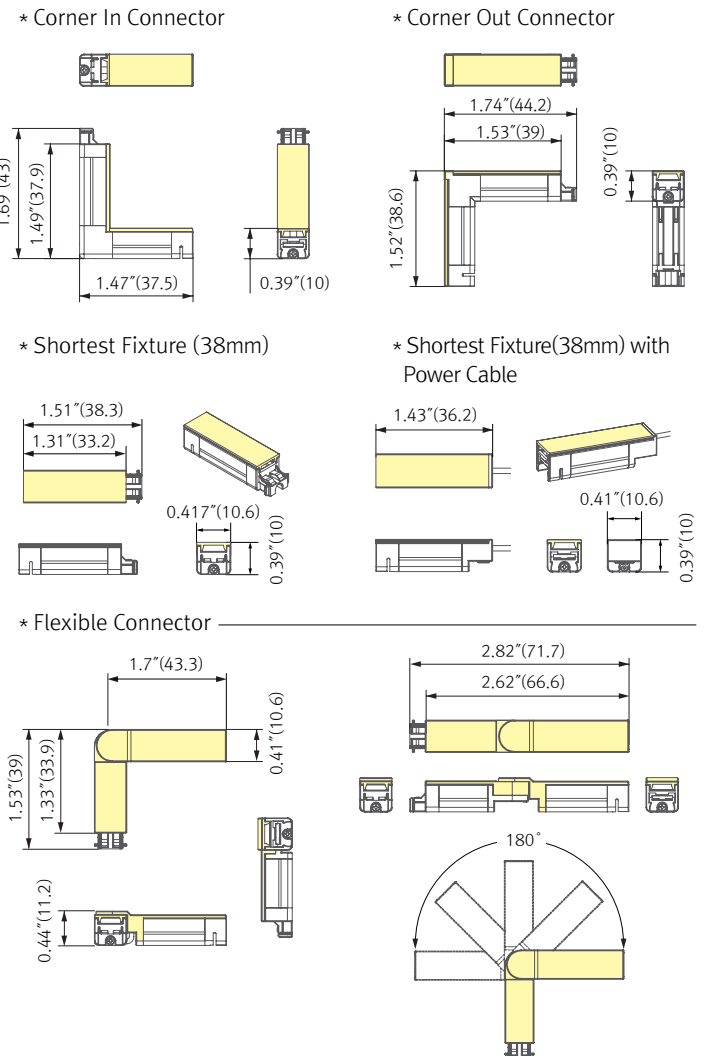

INLINE DIMMER

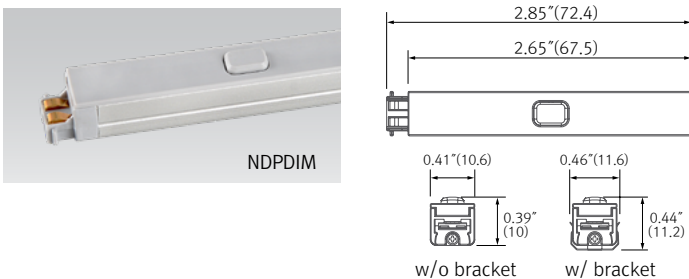

LED DRIVER OPTIONS

- Consult factory for additional options.

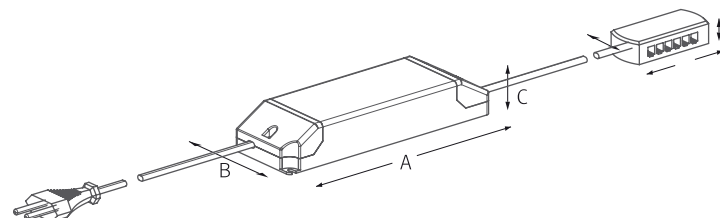

Model Name	A inches (mm)	B inches (mm)	C inches (mm)
FLC30-24V/XL	5.9\"(150)	1.6\"(41)	1.22\"(31)
FLC75-24V/XL	7.08\"(180)	2.36\"(60)	1.25\"(32)
XLD75-124V-FC	11.22\"(285)	2.94\"(74.7)	1.63\"(41.5)
XLD200-224V-FCL-DIM	12.28\"(312)	4.46\"(113.5)	2.28\"(60.5)
XLAV80(L)-124V-SSB	14.4\"(366)	4.48\"(124)	1.7\"(43)

CONNECTION

NO RUN TO EXCEED 55W

IF LONGER RUNS ARE REQUIRED USE SIDE FEED UNIT NDV3-(COLOR)K-24V-S TO CONTINUE SEAMLESS LIGHTING. NOT TO EXCEED 90% OF DRIVER RATED WATTAGE.

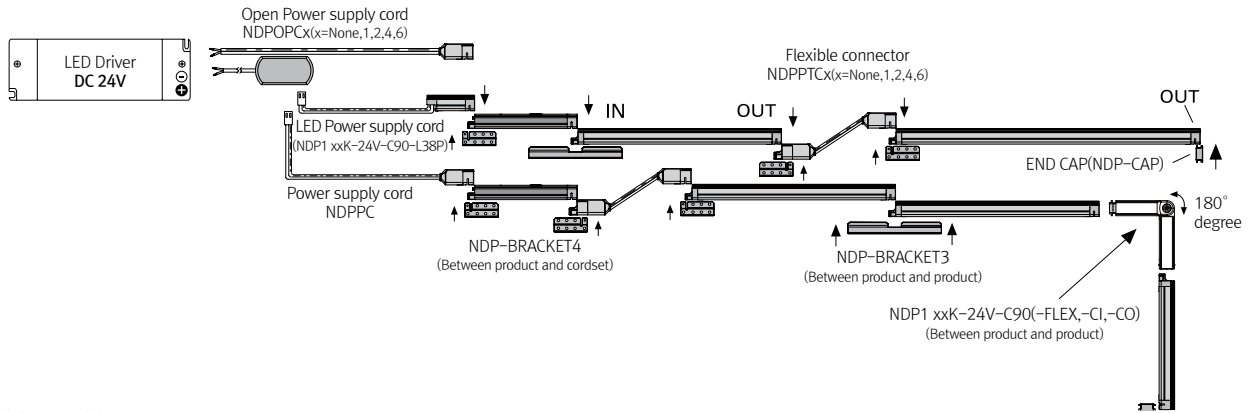

SIDE FEED UNIT

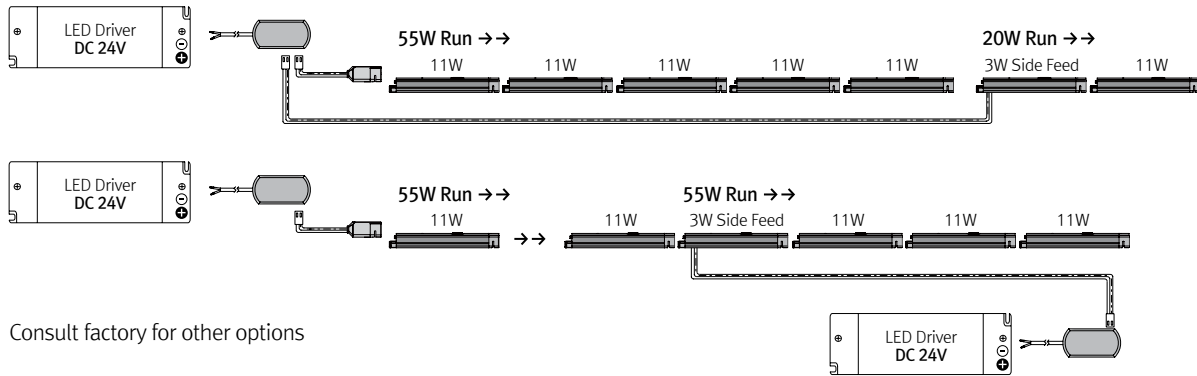

Consult factory for other options

CAN POWER UP TO 55 WATT MAX FIXTURE LOAD. CONNECTED LINE OF LIGHT REQUIRES SIDE FEED EVERY 15FT(55WATT). TOTAL CONNECTED LOAD SHOULD NOT EXCEED 90% OF DRIVER WATTS

BEAM SPREADS

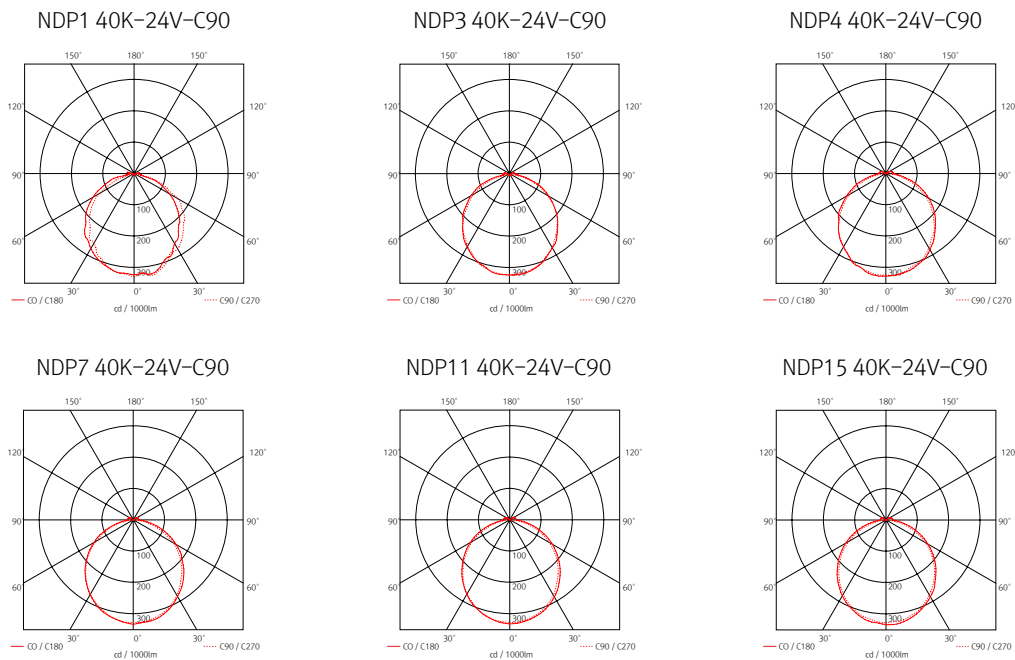

COMPONENTS

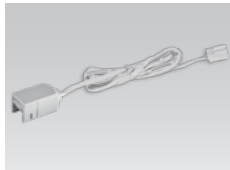

Power cable
 __NDPPC (8')
 __NDPPC (13')



Occupancy Sensor
 __NDP-OSM
 NDP Occupancy Sensor
 Inline Module



12 Port Hub
 __D12P-HUB
 Included with Cord and Plug
 drivers. Order separately for
 Hard Wire or 3rd Party Drivers



Connecting Cable
 __NDPPTC (6')
 __NDPPTC1 (1')
 __NDPPTC2 (2')
 __NDPPTC4 (4')
 __NDPPTC6 (6')



Touch Switch
 __NDPTS
 NDP ON/OFF touch switch

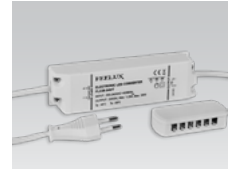

LED Drivers
 __FLC30-24V/XL
 __FLC75-24V/XL
 with distributor and power
 cord (1800mm)



LED Power cable
 __NDP1-(color)K 24V-C90-
 L38P
 w/96" cable
 Lighted section is 1.4" (36mm)



End Cap
 __NDP-CAP
 Included with fixture



Hard Wire Driver
 __XLAV80(L)-124V-SSB
 __XLD200-224V-FCL-DIM
 __XLD75-124V-FC
 (90V to 300V)



**Sidefeed for Seamless
 Extension (3W)**
 __NDP3-(color)K-24V-S

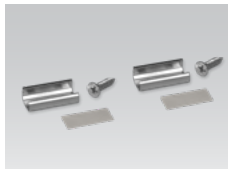

**Metal Mounting
 Brackets**
 __NDV-BRACKET1
 Included with fixture



Justin Drivers
 __481-24DCR
 __483-24DCR-277
 __961-24DCR
 __963-24DCR-277
 __C2240-24DCR
 __C2240-24DCR-277



Flexible Connector
 __NDP1-(color)K-24V-FLEX



Angled Brackets
 __NDV-BRACKET2
 Angled 15° / 40° (BK2)
 Optional

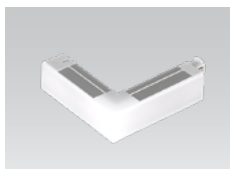

Corner Out Connector
 __NDP1-(color)K-24V-
 C90-CO



Connecting Brackets
 __NDV-BRACKET3
 Fixture to Fixture
 Included with fixture



Dimming Interface
 __FDC-L10
 Max. 100W (100W/CH, 1CH)
 0-10V Signal



Corner In Connector
 __NDP1-(color)K-24V-
 C90-CI



Power Brackets
 __NDV-BRACKET4
 Included with NDPPC
 and NDPPTC

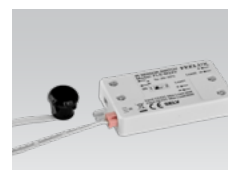

**Door and motion
 sensor**
 __FLS-M24V



In-Line Dimmer
 __NDPDIM
 (Max 55W in a row)



Magnet Brackets
 __NDP-BRACKET-M



Occupancy sensor
 __FLS-P24V

A larger selection of drivers are available including remote and hard wire drivers. Please consult factory.

SPECIFICATION GUIDE

NOT TO BE USED FOR ORDERING. The Specification Guide is intended solely to ensure that all options are considered.

MODEL	COLOR	C90	MOUNTING	CONFIGURATION	RUN LENGTH	DRIVER	CONTROLS	VOLTAGE
NDP		C90			ft.			
NDP	27K -2700K 30K -3000K 35K -3500K 40K -4000K 60K -6000K*		STD Flat Brackets Magnets Included BK2 15° /40° Brackets	S -Straight V -Varies*	RUN LENGTH IN FEET Fill out for every run section *DRAWINGS AND RUN LENGTH REQUIRED	CP - Cable/Plug HW - Hard Wire TD - 3rd Party Drivers Consult Factory	NDM Non-Dim IDM Inline Dim FDC 0-10V Interface FPH Forward Phase RPH Reverse Phase TS Touch Sensor OSM Occupancy Sensor	100V 120V 230V 277V

* Available, consult Feelux Lighting

NOTE: No Run to Exceed 55W without use of Side Feed Unit

* Consult NDP Installation instructions for more information